



**POWERFUL
DUST
REMOVAL
AT SOURCE**

EJOT[®] vortex SDS

**Modular drill bit system
for SDS Plus drills**

Instant dust extraction when drilling
concrete, brick and block substrates.



EJOT[®]
The Quality Connection

EJOT® vortex SDS

Powerful Dust Extraction at Source

The unique engineering of EJOT vortex-SDS ticks the health & safety boxes set out by the HSE, whilst operating with high accuracy and quicker installation for building and construction professionals.

The vented four-cutter design of each carbide drill tip initiates the powerful dust extracting 'vortex' created inside each operating component. An integral 16amp socket connector means that the dust extraction occurs instantly, as the drill is activated and continues to draw dust and debris for a full ten seconds after drilling has finished.

REGULAR SDS DRILL BIT



Vortex-SDS DRILL BIT



HIGH GRADE MATERIAL STRENGTH

The four-cutter design of all EJOT vortex-SDS drilling components creates a more precise drill hole whilst remaining noticeably cooler than standard drill bits.

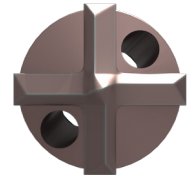

Vortex-SDS STANDARD DRILL BITS

Four standard drill bits from 8-14mm diameter and up to 145mm depth.

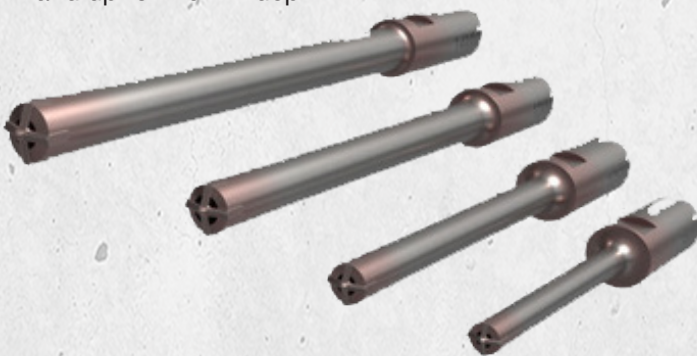

KEY BENEFITS

- **POWERFUL** dust removal at source
- **REDUCES** potential hazards to health
- **INSTANT** dust removal reduces drilling time
- **LESS TIME** spent cleaning drill hole
- **LESS DEBRIS** means longer drill bit life
- **INDIVIDUAL** components available separately
- **INSTANT** connection between drill and vacuum
- **EXTRACTION** continues when drilling stops
- **ONE TRAILING CABLE** minimising trip hazards

Vortex-SDS MODULAR SYSTEM

Modular drill bits for extended drilling range and replaceability.



Four interchangeable drill bits for everyday site drilling applications.

EJOT vortex-SDS will work with most H-Class Industrial Vacuum Cleaners

EJOT has partnered international manufacturer Addex to provide a customised version of the MV-DV20 VAC.

- Wet and dry capability
- Automatic drill trigger
- One 10 metre trailing cable



EJOT® vortex-SDS drilling system

Technical specifications

The EJOT vortex-SDS drilling system has been developed in response to the increasing HSE focus in the UK, on dust removal at source, on site.

The system instantly extracts potentially harmful dust and debris whilst still providing high accuracy, faster installation and cost benefits.

All items sold individually or as part of the EJOT vortex-SDS dust-free drill kit. The 'Vortex-SDS' drill extension can also be purchased separately to extend the possible drill depth to up to 450mm when used in conjunction with an existing 'Vortex-SDS' drill extension and modular bit of 20mm diameter.



EJOT®

Engineered with high quality carbide tips

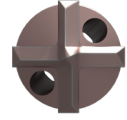

EJOT vortex-SDS DRILL TO HOSE CONNECTOR

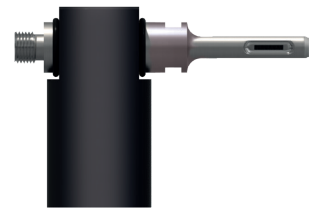

Vortex-SDS STANDARD DRILL BITS 8-14mm

Threaded directly on to the EJOT vortex-SDS drill hose connector.

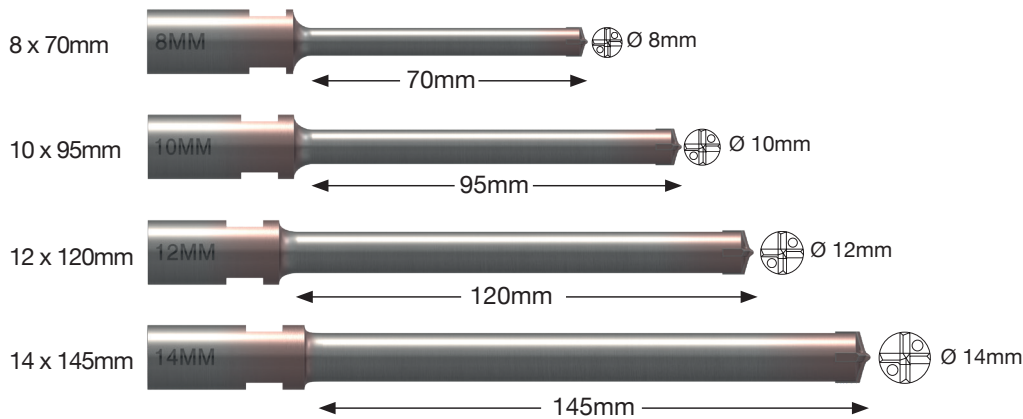

Vortex-SDS MODULAR SYSTEM 16-20mm

SDS extension bar with 3 x modular drill bits.

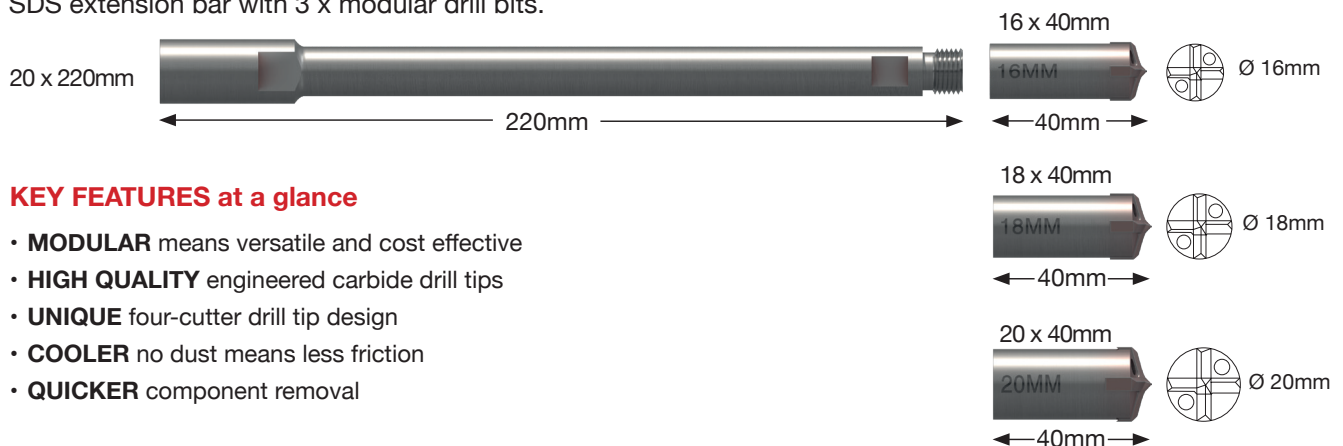

KEY FEATURES at a glance

- **MODULAR** means versatile and cost effective
- **HIGH QUALITY** engineered carbide drill tips
- **UNIQUE** four-cutter drill tip design
- **COOLER** no dust means less friction
- **QUICKER** component removal

After-care and Maintenance

Keep your EJOT vortex-SDS drill bits in the best condition by treating the surface after each use with a high quality lubricant.

- Clean each item of any debris or dirt
- Spray or wipe each item sparingly with your chosen product
- Lightly rub with a soft, clean cloth and place back in your EJOT vortex-SDS carry case

EJOT UK Limited, Hurricane Close, Sherburn Enterprise Park, Sherburn-in-Elmet, Leeds LS25 6BP. United Kingdom

Tel: +44 1977 68 70 40 Fax: +44 1977 68 70 41 Email: info@ejot.co.uk www.ejot.co.uk

EJOT® The Quality Connection

EJOT® vortex V

Specialist industrial vacuum cleaner





As part of the EJOT vortex-SDS system offering, EJOT has partnered international manufacturer Addex to provide a customised version of the MV-DV20 VAC.

EJOT vortex V is a certified H-Class single motor vacuum. It has 1100watt power take off and a 20 litre drum.

The vortex V comes complete with power tool hose and one vacuum bag (replacement bags available to buy separately).

Key Features

-  10 meter cable

-  Wet and dry

-  Non-mark wheels

Features and Benefits

- H-class accreditation
- Wet and dry capability
- 1100w power take off
- Auto filter clean
- Longer lasting filter
- Higher suction for longer

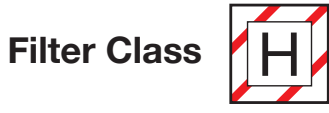

Voltage	110v
Motor	1200w
Filter type	Cartridge
Air flow rate	55 litres/sec
Power cord length	10 metres
Capacity	20 litres
Maximum power tool output	1100w
Noise level	~dB(A) <68
Dimensions	500 x 500 x 600 height mm
Weight	11kg

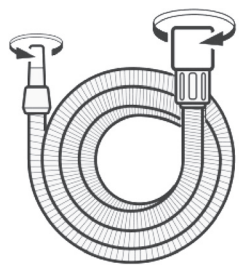

Hose Diameter 36mm



Vacuum Bag

EJOT UK Limited, Hurricane Close, Sherburn Enterprise Park, Sherburn-in-Elmet, Leeds LS25 6BP. United Kingdom

Tel: +44 1977 68 70 40 Fax: +44 1977 68 70 41 Email: info@ejot.co.uk www.ejot.co.uk

EJOT® The Quality Connection