

European Technical Assessment

ETA-15/0282 of 02/06/2015

English translation prepared by CSTB - Original version in French language

General Part

Technical Assessment Body issuing the ETA and designated according to Article 29 of the Regulation (EU) No 305/2011:

Nom commercial
Trade name

EJOT Multifix VSF

Famille de produit
Product family

Cheville à scellement de type "à injection" pour fixation dans le béton : M8 à M24, fers à béton 8 à 25mm

Bonded injection type anchor for use in concrete: sizes M8 to M24, rebar 8 to 25mm

Titulaire
Manufacturer

EJOT Baubefestigungen GmbH
In der Stockwiese 35
57334 BAD LAASPHE
Germany

Usine de fabrication
Manufacturing plants

Plant 1

Cette évaluation contient:
This Assessment contains

22 pages incluant 19 pages d'annexes qui font partie intégrante de cette évaluation

22 pages including 19 pages of annexes which form an integral part of this assessment

Base de l'ETE
Basis of ETA

ETAG 001, Version April 2013, utilisée en tant que EAD
ETAG 001, Edition April 2013 used as EAD

Cette évaluation remplace:
This Assessment replaces

Specific part

1 Technical description of the product

The EJOT Multifix VSF is a bonded anchor (injection type) consisting of a mortar cartridge with EJOT chemical anchoring resin Multifix VSF and a steel element. The steel elements are threaded rods made of zinc coated steel, stainless steel, high corrosion resistant stainless steel (HCR), or rebar.

The steel element is placed into a drilled hole filled with injection mortar and is anchored via the bond between steel element, injection mortar and concrete. The steel element is intended to be used with embedment depth from 4 diameters to 20 diameters.

The illustration and the description of the product are given in Annexes A.

2 Specification of the intended use

The performances given in Section 3 are only valid if the anchor is used in compliance with the specifications and conditions given in Annexes B.

The provisions made in this European Technical Assessment are based on an assumed working life of the anchor of 50 years. The indications given on the working life cannot be interpreted as a guarantee given by the producer, but are to be regarded only as a means for choosing the right products in relation to the expected economically reasonable working life of the works.

3 Performance of the product

3.1 Mechanical resistance and stability (BWR 1)

Essential characteristic	Performance
Characteristic resistance under tension loads for threaded rod Acc. TR029	See Annex C 1
Characteristic resistance under tension loads for rebars Acc. TR029	See Annex C 2
Characteristic resistance under shear loads for threaded rods Acc. TR029	See Annex C 3
Characteristic resistance under shear loads for rebars Acc. TR029	See Annex C 4
Characteristic resistance under tension loads for threaded rods Acc. CEN/TS	See Annex C 5
Characteristic resistance under tension loads for rebars Acc. CEN/TS	See Annex C 6
Characteristic resistance under shear loads for threaded rods Acc. CEN/TS	See Annex C 7
Characteristic resistance under shear loads for rebars Acc. CEN/TS	See Annex C 8
Displacement for threaded rods and rebars	See Annex C 9

3.2 Safety in case of fire (BWR 2)

Essential characteristic	Performance
Reaction to fire	Anchorage satisfy requirements for Class A1
Resistance to fire	No performance determined (NPD)

3.3 Hygiene, health and the environment (BWR 3)

Regarding dangerous substances contained in this European Technical Assessment, there may be requirements applicable to the products falling within its scope (e.g. transposed European legislation and national laws, regulations and administrative provisions). In order to meet the provisions of the Construction Products Directive, these requirements need also to be complied with, when and where they apply.

3.4 Safety in use (BWR 4)

For basic requirement safety in use the same criteria are valid as for basic requirement mechanical resistance and stability.

3.5 Protection against noise (BWR 5)

Not relevant.

3.6 Energy economy and heat retention (BWR 6)

Not relevant.

3.7 General aspects relating to fitness for use

Durability and serviceability are only ensured if the specifications of intended use according to Annex B1 are kept.

4 Assessment and verification of constancy of performance (AVCP)

According to the Decision 96/582/EC of the European Commission¹, as amended, the system of assessment and verification of constancy of performance (see Annex V to Regulation (EU) No 305/2011) given in the following table apply.

Product	Intended use	Level or class	System
Metal anchors for use in concrete	For fixing and/or supporting to concrete, structural elements (which contributes to the stability of the works) or heavy units	—	1

5 Technical details necessary for the implementation of the AVCP system

Technical details necessary for the implementation of the Assessment and verification of constancy of performance (AVCP) system are laid down in the control plan deposited at Centre Scientifique et Technique du Bâtiment.

The manufacturer shall, on the basis of a contract, involve a notified body approved in the field of anchors for issuing the certificate of conformity CE based on the control plan.

The original French version is signed by

Charles Baloche
Technical Director

¹ Official Journal of the European Communities L 254 of 08.10.1996

Threaded rod M8, M10, M12, M16, M20, M24

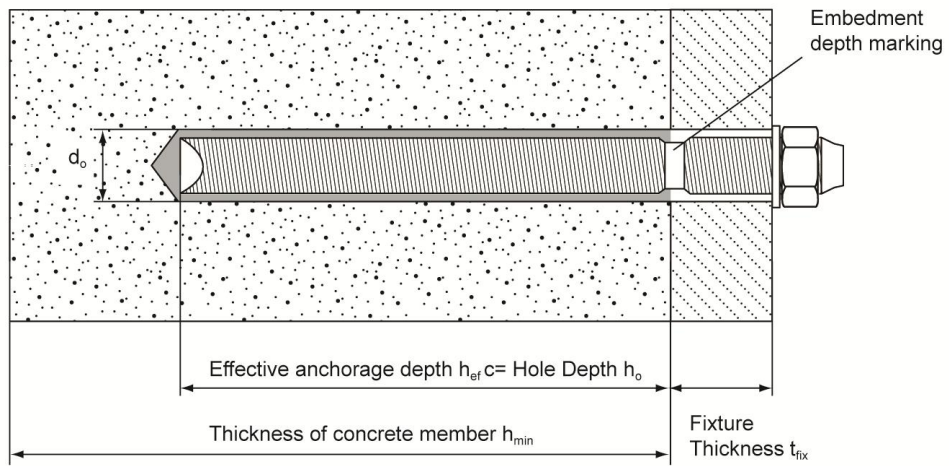

Reinforcing bar Ø8, Ø10, Ø12, Ø14, Ø16, Ø20, Ø25 acc. to Annex 4

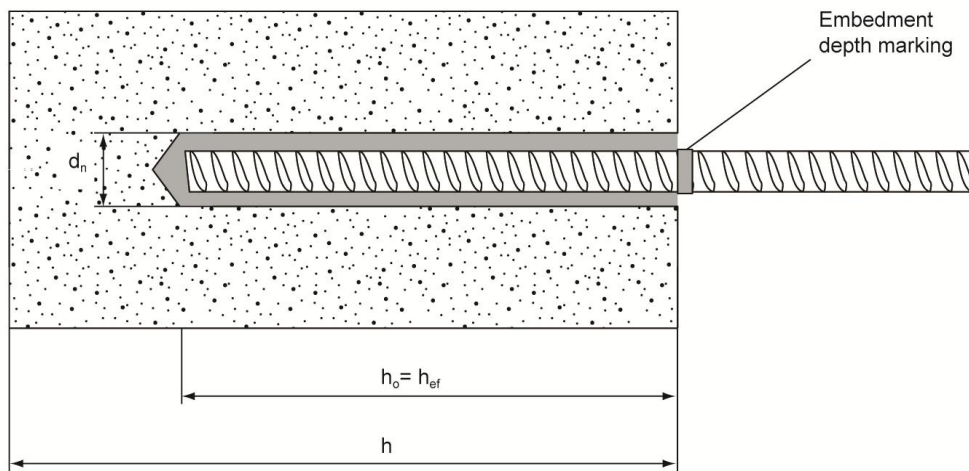

EJOT Multifix VSF

Product description
 Installation condition

Annex A1

Injection mortar : EJOT Multifix VSF

Foil Bag Cartridge 165ml - 410ml



Coaxial Cartridge
380ml - 410ml



Side by Side Cartridge
235ml - 825ml

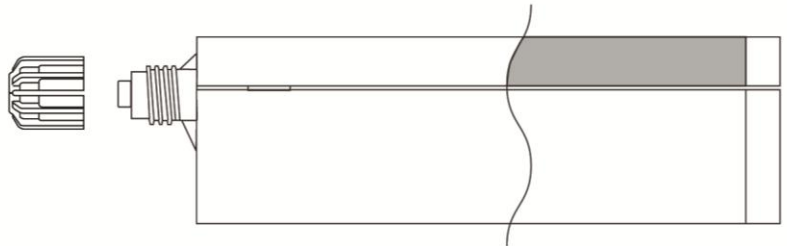

Marking:

Multifix VSF

Batch code, either expiry date or manufacturing date with shelf life

Mixer with hanger

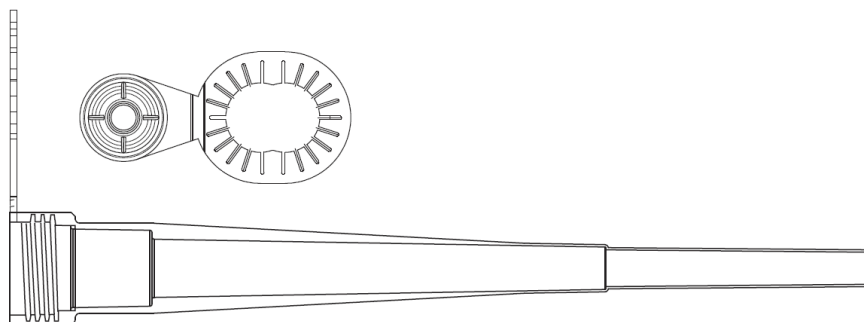

EJOT Multifix VSF

Product description

Injection system

Annex A2

Anchor rod and rebar:

Threaded Steel Stud, Nut and Washer
 Sizes M8, M10, M12, M16, M20, M24.

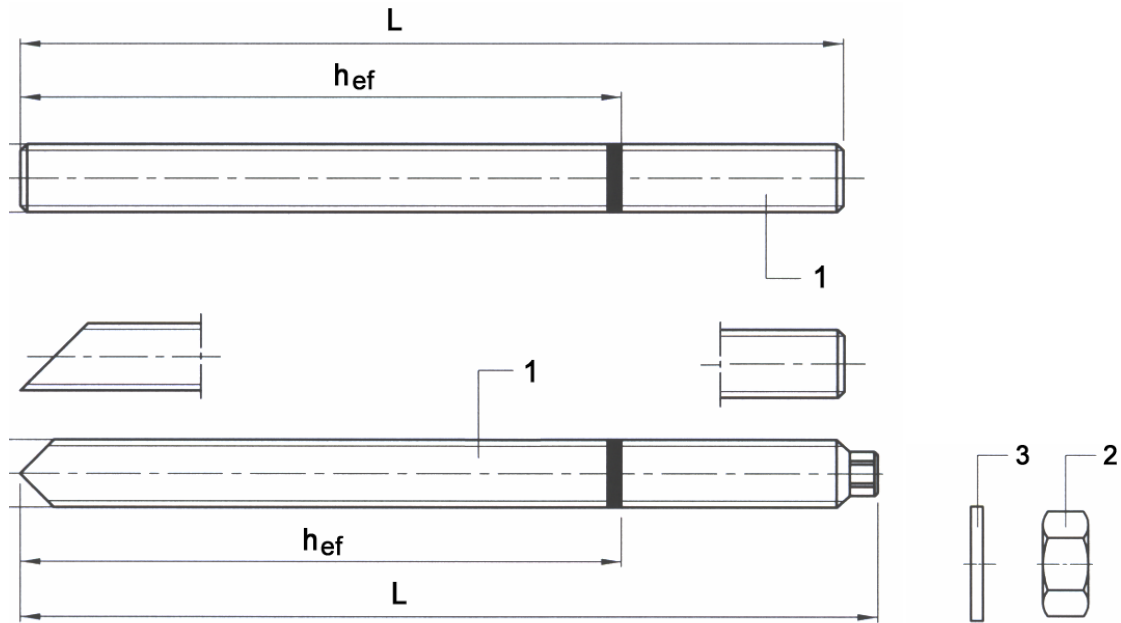

Commercial standard rod with:

- Materials, dimensions and mechanical properties (Table 1a)
- Inspection certificate 3.1 acc. to EN 10204:2004
- Marking of embedment depth

Rebar

Diameter \varnothing 8mm, \varnothing 10mm, \varnothing 12mm, \varnothing 14mm, \varnothing 16mm, \varnothing 20mm, \varnothing 25mm



EJOT Multifix VSF

Product description

Threaded rods and rebars

Annex A3

Table A1: Materials

Designation	Material
Threaded rods made of zinc coated steel	
Threaded rod M8 – M24	Strength class 5.8, 8.8, 10.9 EN ISO 898-1, Steel galvanized $\geq 5\mu\text{m}$ EN ISO 4042, Hot dipped galvanized $\geq 45\mu\text{m}$ EN ISO 10684
Washer ISO 7089	Steel galvanized EN ISO 4042; hot dipped galvanized EN ISO 10684
Nut EN ISO 4032	Strength class 8 EN ISO 898-2 Steel galvanized $\geq 5\mu\text{m}$ EN ISO 4042 Hot dipped galvanized $\geq 45\mu\text{m}$ EN ISO 10684
Threaded rods made of stainless steel	
Threaded rod M8 – M24	For \leq M24: strength class 70 EN ISO 3506-1; Stainless steel 1.4401; 1.4404; 1.4578; 1.4571; 1.4439; 1.4362 EN 10088
Washer ISO 7089	Stainless steel 1.4401; 1.4404; 1.4578; 1.4571; 1.4439; 1.4362 EN 10088
Nut EN ISO 4032	Strength class 70 EN ISO 3506-2 Stainless steel 1.4401; 1.4404; 1.4578; 1.4571; 1.4439; 1.4362 EN 10088
Threaded rods made of high corrosion resistant steel	
Threaded rod M8 – M24	For \leq M20: $R_m = 800\text{ N/mm}^2$; $R_{p0,2} = 640\text{ N/mm}^2$, For $>$ M20: $R_m = 700\text{ N/mm}^2$; $R_{p0,2} = 400\text{ N/mm}^2$, High corrosion resistant steel 1.4529, 1.4565 EN 10088
Washer ISO 7089	High corrosion resistant steel 1.4529, 1.4565 EN 10088
Nut EN ISO 4032	Strength class 70 EN ISO 3506-2 High corrosion resistant steel 1.4529, 1.4565 EN 10088

Table A2: Properties of reinforcement bars (rebars)

Product form	Bars and de-coiled rods	
Class	B	C
Characteristic yield strength f_{yk} or $f_{0,2k}$ (MPa)	400 to 600	
Minimum value of $k = (f_t / f_y)k$	$\geq 1,08$	$\geq 1,15$ $< 1,35$
Characteristic strain at maximum force, ϵ_{uk} (%)	$\geq 5,0$	$\geq 7,5$
Bendability	Bend / Rebend test	
Maximum deviation from nominal mass (individual bar) (%)	Nominal bar size (mm) ≤ 8	$\pm 6,0$
	> 8	$\pm 4,5$
Bond: Minimum relative rib area, $f_{R,min}$ (determination according to EN 15630)	Nominal bar size (mm) 8 to 12	0,040
	> 12	0,056

Height of the rebar rib h_{rib} :

The height of the rebar rib h_{rib} shall fulfil the following requirement: $0,05 * d \leq h_{rib} \leq 0,07 * d$
 with: d = nominal diameter of the rebar

EJOT Multifix VSF

Product description

Threaded rods and rebars

Annex A4

Specifications of intended use

Anchorage subject to:

- Static and quasi-static loads

Base materials:

- Cracked concrete and non-cracked concrete
- Reinforced or unreinforced normal weight concrete of strength classes C 20/25 at least to C50/60 at most according to ENV 206: 2000-12.

Temperature Range:

- Ta: - 40°C to +40°C (max. short term temperature +40°C and max. long term temperature +24°C)
- Tb: - 40°C to +80°C (max. short term temperature +80°C and max. long term temperature +50°C)

Use conditions (Environmental conditions):

- Structures subject to dry internal conditions (zinc coated steel, stainless steel, high corrosion resistance steel).
- Structures subject to permanently damp internal condition, if no particular aggressive conditions exist (stainless steel, high corrosion resistance steel).
- Structures subject to permanently damp internal condition, with particular aggressive conditions (high corrosion resistance steel).
- Structures subject to external atmospheric exposure including industrial and marine environment if no particular aggressive conditions exist (stainless steel, high corrosion resistance steel).

Note: Particular aggressive conditions are e.g. permanent, alternating immersion in seawater or the splash zone of seawater, chloride atmosphere of indoor swimming pools or atmosphere with extreme chemical pollution (e.g. in desulphurization plants or road tunnels where de-icing materials are used).

Design:

- The anchorages are designed in accordance with the EOTA Technical Report TR 029 "Design of bonded anchors" and CEN/TS 1992-4-5 "Design of fastenings for use in concrete" under the responsibility of an engineer experienced in anchorages and concrete work
- Verifiable calculation notes and drawings are prepared taking account of the loads to be anchored. The position of the anchor is indicated on the design drawings.

Installation:



- Dry or wet concrete (category 1).
- Hole drilling by rotary drill mode.
- Overhead installation is not permitted
- Installation in cracked concrete for threaded rods sizes M12 and M16 only
- Anchor installation carried out by appropriately qualified personnel and under the supervision of the person responsible for technical matters of the site.

EJOT Multifix VSF

Intended Use
Specifications

Annex B1

Table B1: Bore hole cleaning method with Steel brush

Threaded rod And rebar	Size	Nominal drill bit diameter d_o (mm)	Steel Brush	Cleaning methods	
				Manual cleaning (MAC)	Compressed air cleaning (CAC)
					
Studs 	M8	10	12mm	Yes ... $h_{ef} \leq 80$ mm	Yes
	M10	12	14mm	Yes ... $h_{ef} \leq 100$ mm	
	M12	14	16mm	Yes ... $h_{ef} \leq 120$ mm	
	M16	18	20mm	Yes ... $h_{ef} \leq 160$ mm	
	M20	24	26mm	Yes ... $h_{ef} \leq 200$ mm	
	M24	28	30mm	Yes ... $h_{ef} \leq 240$ mm	
Rebar 	Ø8	12	14mm	Yes ... $h_{ef} \leq 80$ mm	Yes
	Ø10	14	16mm	Yes ... $h_{ef} \leq 100$ mm	
	Ø12	16	18mm	Yes ... $h_{ef} \leq 120$ mm	
	Ø14	18	20mm	Yes ... $h_{ef} \leq 140$ mm	
	Ø16	20	22mm	Yes ... $h_{ef} \leq 160$ mm	
	Ø20	25	28mm	Yes ... $h_{ef} \leq 200$ mm	
	Ø25	32	34mm	Yes ... $h_{ef} \leq 240$ mm	

Manual Cleaning (MAC):

EJOT hand pump recommended for blowing out bore holes with diameters $d_o \leq 24$ mm and bore holes depth $h_o \leq 10d$



Compressed air cleaning (CAC):

Recommended air nozzle with an orifice opening of minimum 3,5mm in diameter.



EJOT Multifix VSF

Intended Use
 Cleaning brush
 Applicator guns

Annex B2

Table B2a: Installation parameters: drilling, hole cleaning and installation

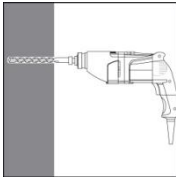
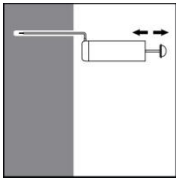
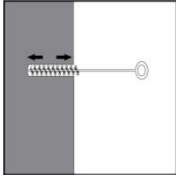
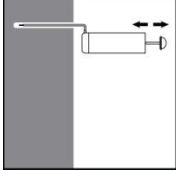
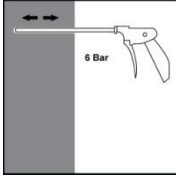
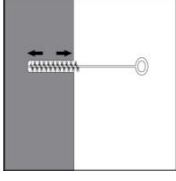
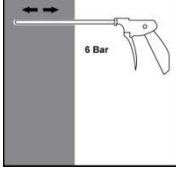
Instructions for use		
Bore hole drilling		
		Drill hole in the substrate to the required embedment depth using the appropriately sized carbide drill bit.
Bore hole cleaning Just before setting an anchor, the bore hole must be free of dust and debris.		
a) Manual air cleaning (MAC) for all bore hole diameters $d_o \leq 24\text{mm}$ and bore hole depth $h_o \leq 10d$		
	X 4	The EJOT manual pump shall be used for blowing out bore holes up to diameters $d_o \leq 24\text{mm}$ and embedment depths up to $h_{ef} \leq 10d$. Blow out at least 4 times from the back of the bore hole, using an extension if needed.
	X 4	Brush 4 times with the specified brush size (see Table B1) by inserting the EJOT steel brush to the back of the hole (if needed with an extension) in a twisting motion and removing it.
	X 4	Blow out again with manual pump at least 4 times.
b) Compressed air cleaning (CAC) for all bore hole diameters d_o and all bore hole depths		
	X 2	Blow 2 times from the back of the hole (if needed with a nozzle extension) over the whole length with oil-free compressed air (min. 6 bar at $6\text{ m}^3/\text{h}$).
	X 2	Brush 2 times with the specified brush size (see Table B1) by inserting the EJOT steel brush to the back of the hole (if needed with an extension) in a twisting motion and removing it.
	X 2	Blow out again with compressed air at least 2 times.

EJOT Multifix VSF

Intended Use

Manufacturer Published Installation Instructions

Annex B3

Table B2b: Installation parameters: drilling, hole cleaning and installation

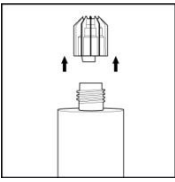
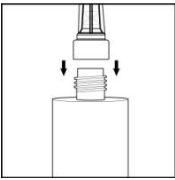
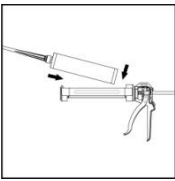
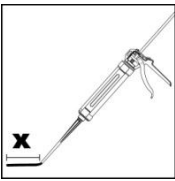
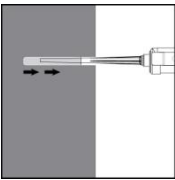
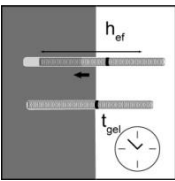
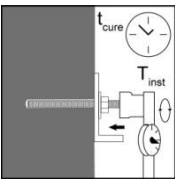
Instructions for use	
	Remove the threaded cap from the cartridge.
	Tightly attach the mixing nozzle. Do not modify the mixer in any way. Make sure the mixing element is inside the mixer. Use only the supplied mixer.
	Insert the cartridge into the EJOT dispenser gun.
	Discard the initial trigger pulls of adhesive. Depending on the size of the cartridge, an initial amount of adhesive mix must be discarded. Discard quantities are - 5cm for between 150ml, 300ml & 400ml Foil Pack - 10cm for all other cartridges
	Inject the adhesive starting at the back of the hole, slowly withdrawing the mixer with each trigger pull. Fill holes approximately 2/3 full, to ensure that the annular gap between the anchor and the concrete is completely filled with adhesive along the embedment depth.
	Before use, verify that the threaded rod is dry and free of contaminants. Install the threaded rod to the required embedment depth during the open gel time t_{gel} has elapsed. The working time t_{gel} is given in Table B3.
	The anchor can be loaded after the required curing time t_{cure} (see Table B3). The applied torque shall not exceed the values T_{max} given in Table B4.

EJOT Multifix VSF

Intended Use
 Manufacturer Published Installation Instructions

Annex B3

Table B3: Minimum curing time

Minimum base material temperature C°	Gel time (working time) t_{gel} In dry/wet concrete	Cure time
$-10^{\circ}\text{C} \leq T_{\text{base material}} < -5^{\circ}\text{C}$	125 min	8 hours
$-5^{\circ}\text{C} \leq T_{\text{base material}} < 0^{\circ}\text{C}$	80 min	160 min
$0^{\circ} \leq T_{\text{base material}} < 5^{\circ}\text{C}$	25 min	90 min
$5^{\circ}\text{C} \leq T_{\text{base material}} < 10^{\circ}\text{C}$	17 min	70 min
$10^{\circ}\text{C} \leq T_{\text{base material}} < 20^{\circ}\text{C}$	12 min	65 min
$20^{\circ}\text{C} \leq T_{\text{base material}} < 30^{\circ}\text{C}$	6 min	60 min
$30^{\circ}\text{C} \leq T_{\text{base material}} \leq 40^{\circ}\text{C}$	3 min	45 min

The temperature of the bond material must be $\geq 20^{\circ}\text{C}$

EJOT Multifix VSF

Intended Use
 Gelling and curing times

Annex B4

Table B4: Installation details for anchor rods

Anchor size			M8	M10	M12	M16	M20	M24
Diameter of anchor rod	d	[mm]	8	10	12	16	20	24
Range of anchorage depth h_{ef} and bore hole depth h_o	min	[mm]	60	60	70	80	90	100
	max	[mm]	160	200	240	320	400	480
Nominal anchorage depth	h_{ef}	[mm]	80	90	110	125	170	210
Nominal diameter of drill bit	d_o	[mm]	10	12	14	18	24	28
Diameter of clearance hole in the fixture	d_f	[mm]	9	12	14	18	22	26
Maximum torque moment	T_{max}	[Nm]	10	20	30	60	90	140
Minimum thickness of concrete member	h_{min}	[mm]	$h_{ef} + 30mm$ $\geq 100mm$			$h_{ef} + 2d_o$		
Minimum spacing	S_{min}	[mm]	40	50	60	80	100	120
Minimum edge distance	C_{min}	[mm]	40	50	60	80	100	120

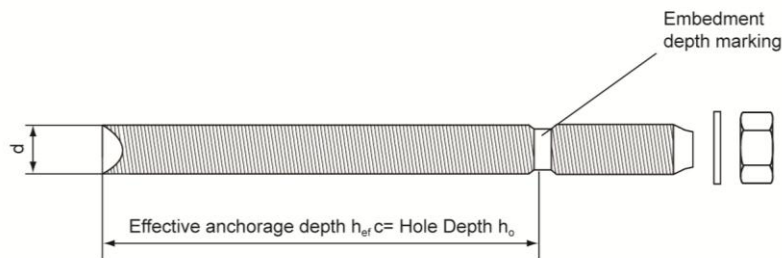
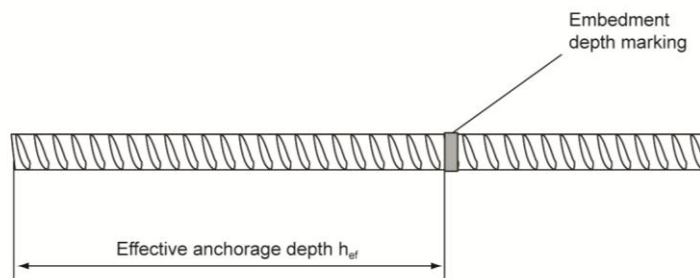

Table B5 - Installation details for rebars

Rebar Diameter			Ø8	Ø10	Ø12	Ø14	Ø16	Ø20	Ø25
Diameter of element	D	[mm]	8	10	12	14	16	20	25
Range of anchorage depth h_{ef} and bore hole depth h_o	min	[mm]	60	60	70	75	80	90	100
	max	[mm]	160	200	240	280	320	400	500
Nominal diameter of drill bit	d_o	[mm]	12	14	16	18	20	25	32
Minimum thickness of concrete member	h_{min}	[mm]	$h_{ef} + 30mm$ $\geq 100mm$			$h_{ef} + 2d_o$			
Minimum spacing	S_{min}	[mm]	40	50	60	70	80	100	125
Minimum edge distance	C_{min}	[mm]	40	50	60	70	80	100	125



EJOT Multifix VSF

Intended Use
 Installation parameters

Annex B5

EJOT Multifix VSF with threaded rods			M8	M10	M12	M16	M20	M24
Steel failure								
Characteristic resistance, class 5.8	$N_{Rk,s}$	[kN]	18	29	42	79	123	177
Characteristic resistance, class 8.8	$N_{Rk,s}$	[kN]	29	46	67	126	196	282
Partial safety factor	$\gamma_{Ms,N}^{1)}$	[-]	1,5					
Characteristic resistance, class 10.9	$N_{Rk,s}$	[kN]	36	58	84	157	245	353
Partial safety factor	$\gamma_{Ms,N}^{1)}$	[-]	1.4					
Characteristic resistance, A4-70	$N_{Rk,s}$	[kN]	26	41	59	110	172	247
Partial safety factor	$\gamma_{Ms,N}^{1)}$	[-]	1,87					
Characteristic resistance, HCR	$N_{Rk,s}$	[kN]	29	46	67	126	196	247
Partial safety factor	$\gamma_{Ms,N}^{1)}$	[-]	1,5					
Combined Pull-out and Concrete cone failure								
Diameter of threaded rod	d	[mm]	8	10	12	16	20	24
Characteristic bond resistance in non-cracked concrete C20/25								
Temperature range I ²⁾ : 40°C/24°C	τ_{Rk}	[N/mm ²]	10.0	9.5	9.0	8.0	7.5	7.0
Temperature range II ²⁾ : 80°C/50°C	τ_{Rk}	[N/mm ²]	9.0	8.0	7.5	7.0	6.5	6.0
Increasing factor for $\tau_{Rk,p}$ in non-cracked concrete	ψ_c	C30/37	1,12					
		C40/50	1,23					
		C50/60	1,30					
Characteristic bond resistance in cracked concrete C20/25								
Temperature range I ²⁾ : 40°C/24°C	τ_{Rk}	[N/mm ²]	- ⁵⁾	- ⁵⁾	3.5	3.5	- ⁵⁾	- ⁵⁾
Temperature range II ²⁾ : 80°C/50°C	τ_{Rk}	[N/mm ²]	- ⁵⁾	- ⁵⁾	3.0	3.0	- ⁵⁾	- ⁵⁾
Increasing factor for $\tau_{Rk,p}$ in cracked concrete	ψ_c	C30/37	1,04					
		C40/50	1,07					
		C50/60	1,09					
Splitting failure²⁾								
Edge distance $c_{cr,sp}$ [mm] for	$h / h_{ef}^{3)} \geq 2,0$		1,0 h_{ef}					
	$2,0 > h / h_{ef}^{3)} > 1,3$		4,6 h_{ef} - 1,8 h					
	$h / h_{ef}^{3)} \leq 1,3$		2,26 h_{ef}					
Spacing	$s_{cr,sp}$	[mm]	2 $c_{cr,sp}$					
Partial safety factor	$\gamma_{Mp} = \gamma_{Mc} = \gamma_{Msp}^{1)}$	[-]	1,5 ⁴⁾	1,5 ⁴⁾	1,5 ⁴⁾	1,5 ⁴⁾	1,5 ⁴⁾	1,5 ⁴⁾

- 1) In absence of national regulations
- 2) Explanations, see Annex B1
- 3) h . concrete member thickness, h_{ef} effective anchorage depth
- 4) The partial safety factor $\gamma_2 = 1,0$ is included
- 5) Not qualified in cracked concrete

EJOT Multifix VSF	Annex C1
Design according to TR 029 Characteristic resistance under tension loads for threaded rods	

EJOT Multifix VSF with rebar			Ø8	Ø10	Ø12	Ø14	Ø16	Ø20	Ø25
Steel failure rebar									
Characteristic resistance for rebar BSt 500 S acc. to DIN 488 ¹⁾	$N_{Rk,s}$	[kN]	28	43	62	85	111	173	270
Partial safety factor for rebar BSt 500 S acc. to DIN 488 ²⁾	$\gamma_{Ms,N}$ ³⁾	[-]	1,4						
Combined Pull-out and Concrete cone failure									
Diameter of rebar	d	[mm]	8	10	12	14	16	20	25
Characteristic bond resistance in non-cracked concrete C20/25									
Temperature range I ⁴⁾ : 40°C/24°C	τ_{Rk}	[N/mm ²]	7,0	7,5	7,0	7,0	6,5	6,5	6,0
Temperature range II ⁴⁾ : 80°C/50°C	τ_{Rk}	[N/mm ²]	6,5	6,5	6,0	6,0	6,0	5,5	5,5
Increasing factor for $\tau_{Rk,p}$ in non-cracked concrete	ψ_c	C30/37	1,12						
		C40/50	1,23						
		C50/60	1,30						
Splitting failure									
Edge distance $c_{cr,sp}$ [mm] for	$h / h_{ef}^{5)} \geq 2,0$		1,0 h_{ef}						
	$2,0 > h / h_{ef}^{5)} > 1,3$		4,6 h_{ef} - 1,8 h						
	$h / h_{ef}^{5)} \leq 1,3$		2,26 h_{ef}						
Spacing	$s_{cr,sp}$	[mm]	2 $c_{cr,sp}$						
Partial safety factor	$\gamma_{Mp} = \gamma_{Mc} = \gamma_{Msp}$ ³⁾	[-]	1,8 ⁶⁾	1,8 ⁶⁾	1,8 ⁶⁾	1,8 ⁶⁾	1,8 ⁶⁾	1,8 ⁶⁾	1,8 ⁶⁾

- 1) The characteristic tension resistance $N_{Rk,s}$ for rebars that do not fulfil the requirements acc. DIN 488 shall be calculated acc. Technical Report TR029, Equation (5.1).
- 2) The partial safety factor $\gamma_{Ms,N}$ for rebars that do not fulfil the requirements acc. DIN 488 shall be calculated acc. Technical Report TR029, Equation (3.3a).
- 3) In absence of national regulations
- 4) Explanation see Annex B1
- 5) h concrete member thickness, h_{ef} effective anchorage depth
- 6) The partial safety factor $\gamma_2 = 1,2$ is included.

EJOT Multifix VSF

Design according to TR 029
 Characteristic resistance under tension loads for rebars

Annex C2

EJOT Multifix VSF with threaded rods		M 8	M 10	M 12	M 16	M 20	M 24	
Steel failure without lever arm								
Characteristic resistance, class 5.8	$V_{Rk,s}$ [kN]	9	15	21	39	61	88	
Characteristic resistance, class 8.8	$V_{Rk,s}$ [kN]	15	23	34	63	98	141	
Characteristic resistance, class 10.9	$V_{Rk,s}$ [kN]	18	29	42	79	123	156	
Characteristic resistance, A4-70	$V_{Rk,s}$ [kN]	13	20	30	55.0	86	124	
Characteristic resistance, HCR	$V_{Rk,s}$ [kN]	15	23	34	62.8	98	124	
Steel failure with lever arm								
Characteristic resistance, class 5.8	$M^0_{Rk,s}$ [Nm]	19	37	66	167	326	561	
Characteristic resistance, class 8.8	$M^0_{Rk,s}$ [Nm]	30.0	60	105	266	519	898	
Characteristic resistance, class 10.9	$M^0_{Rk,s}$ [Nm]	38	75	131	333	649	893	
Characteristic resistance, A4-70	$M^0_{Rk,s}$ [Nm]	26	53	92	233	454	625	
Characteristic resistance, HCR	$M^0_{Rk,s}$ [Nm]	30	60	105	266	519	786	
Partial safety factor steel failure								
grade 5.8 or 8.8	$\gamma_{Ms,V}^{1)}$ [-]	1,25						
grade 10.9	$\gamma_{Ms,V}^{1)}$ [-]	1,50						
A4-70	$\gamma_{Ms,V}^{1)}$ [-]	1,56						
HCR	$\gamma_{Ms,V}^{1)}$ [-]	1,25					1,75	
Concrete pryout failure								
Factor in equation (5.7) of Technical Report TR029 for the design of bonded anchors	k [-]	2,0						
Partial safety factor	$\gamma_{Mcp}^{1)}$ [-]	1,5 ²⁾						
Concrete edge failure³⁾								
Partial safety factor	$\gamma_{Mc}^{1)}$ [-]	1,5 ²⁾						

- 1) In absence of national regulations
 2) The partial safety factor $\gamma_2= 1.0$ is included
 3) Concrete edge failure see chapter 5.2.3.4 of Technical Report TR029

EJOT Multifix VSF

Design according to TR 029
 Characteristic resistance under shear loads for threaded rods

Annex C3

EJOT Multifix VSF with rebar			Ø8	Ø10	Ø12	Ø14	Ø16	Ø20	Ø25
Steel failure without lever arm									
Characteristic shear resistance for rebar BSt 500 S acc. to DIN 488 ¹⁾	$V_{Rk,s}$	[kN]	14	22	31	42	55	86	135
Partial safety factor for rebar BSt 500 S acc. to DIN 488 ²⁾	$\gamma_{Ms,V}$ ³⁾	[-]	1,5						
Steel failure with lever arm									
Characteristic shear resistance for rebar BSt 500 S acc. to DIN 488 ⁴⁾	$M^0_{Rk,s}$	[Nm]	33	65	112	178	265	518	1012
Partial safety factor for rebar BSt 500 S acc. to DIN 488 ³⁾	$\gamma_{Ms,V}$ ³⁾	[-]	1,5						
Concrete pryout failure									
Factor in equation (5.7) of Technical Report TR029 for the design of bonded anchors	k	[-]	2,0						
Partial safety factor	γ_{Mcp} ³⁾	[-]	1,5 ⁵⁾						
Concrete edge failure⁶⁾									
Partial safety factor	γ_{Mc} ³⁾	[-]	1,5 ⁵⁾						

- 1) The characteristic shear resistance $V_{Rk,s}$ for rebars that do not fulfil the requirements acc. DIN 488 shall be calculated acc. Technical Report TR029, Equation (5.6).
- 2) The partial safety factor $\gamma_{Ms,N}$ for rebars that do not fulfil the requirements acc. DIN 488 shall be calculated acc. Technical Report TR029, Equation 3.3b or 3.3c.
- 3) In absence of national regulations
- 4) The characteristic bending resistance $M^0_{Rk,s}$ for rebars that do not fulfil the requirements acc. DIN 488 shall be calculated acc. Technical Report TR029, Equation (5.6b).
- 5) The partial safety factor $\gamma_2 = 1,0$ is included.
- 6) Concrete edge failure see chapter 5.2.3.4 of Technical Report TR029

EJOT Multifix VSF

Design according to TR 029
 Characteristic resistance under shear loads for rebars

Annex C4

EJOT Multifix VSF with threaded rods			M 8	M 10	M 12	M 16	M 20	M 24
Steel failure								
Characteristic resistance, class 5.8	$N_{Rk,s}$	[kN]	18	29	42	79	123	177
Characteristic resistance, class 8.8	$N_{Rk,s}$	[kN]	29	46	67	126	196	282
Partial safety factor	$\gamma_{Ms,N}^{1)}$	[-]	1.50					
Characteristic resistance, class 10.9	$N_{Rk,s}$		36	58	84	157	245	353
Partial safety factor	$\gamma_{Ms,N}^{1)}$		1.40					
Characteristic resistance "A4 70"	$N_{Rk,s}$	[kN]	26	41	59	110	172	247
Partial safety factor	$\gamma_{Ms,N}^{1)}$	[-]	1.87					
Characteristic resistance "HCR"	$N_{Rk,s}$	[kN]	29	46	67	126	196	247
Partial safety factor	$\gamma_{Ms,N}^{1)}$	[-]	1.5					
Combined Pull-out and Concrete cone failure								
Diameter of threaded rod	d	[mm]	8	10	12	16	20	24
Characteristic bond resistance in non-cracked concrete C20/25								
Temperature range I ²⁾ : 40°C/24°C	$\tau_{Rk,uncr}$	[N/mm ²]	10.0	9.5	9.0	8.0	7.5	7.0
Temperature range II ²⁾ : 80°C/50°C	$\tau_{Rk,uncr}$	[N/mm ²]	9.0	8.0	7.5	7.0	6.5	6.0
Increasing factor for $\tau_{Rk,p}$ in non-cracked concrete	ψ_c	C30/37	1,12					
		C40/50	1,23					
		C50/60	1,30					
Characteristic bond resistance in cracked concrete C20/25								
Temperature range I ²⁾ : 40°C/24°C	$\tau_{Rk,cr}$	[N/mm ²]	- ⁵⁾	- ⁵⁾	3.5	3.5	- ⁵⁾	- ⁵⁾
Temperature range II ²⁾ : 80°C/50°C	$\tau_{Rk,cr}$	[N/mm ²]	- ⁵⁾	- ⁵⁾	3.0	3.0	- ⁵⁾	- ⁵⁾
Increasing factor for τ_{Rk} in cracked concrete	ψ_c	C30/37	1,04					
		C40/50	1,07					
		C50/60	1,09					
Factor according to CEN/TS 1992-4-5 Section 6.2.2	$\frac{k_8 \text{ non cracked concrete}}{k_8 \text{ cracked concrete}}$	[-]	10.1					
		[-]	7.2					
Concrete cone failure								
Factor according to CEN/TS 1992-4-5 Section 6.2.3	k_{ucr}	[-]	10.1					
		[-]	7.2					
Edge distance	$C_{cr,N}$	[-]	1,5 h _{ef}					
Axial distance	$S_{cr,N}$	[-]	3,0 h _{ef}					
Splitting failure								
Edge distance $C_{cr,sp}$ [mm] for	$h / h_{ef}^{3)} \geq 2,0$		1,0 h _{ef}					
	$2,0 > h / h_{ef}^{3)} > 1,3$		4,6 h _{ef} - 1,8 h					
	$h / h_{ef}^{3)} \leq 1,3$		2,26 h _{ef}					
Spacing	$S_{cr,sp}$	[mm]	2 · C _{cr,sp}					
Partial safety factor	$\gamma_{Mp} = \gamma_{Mc} = \gamma_{Msp}^{1)}$	[-]	1,5 ⁴⁾	1,5 ⁴⁾	1,5 ⁴⁾	1,5 ⁴⁾	1,5 ⁴⁾	1,5 ⁴⁾

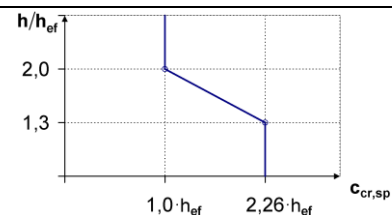

- 1) In absence of national regulations
- 2) Explanations, see Annex B1
- 3) h concrete member thickness, h^{ef} effective anchorage depth
- 4) The partial safety factor $\gamma_2 = 1,0$ is included
- 5) Not qualified in cracked concrete

EJOT Multifix VSF

Design according to CEN/TS 1992-4
Characteristic resistance under tension loads for threaded rods

Annex C5

EJOT Multifix VSF with rebar			Ø8	Ø10	Ø12	Ø14	Ø16	Ø20	Ø25
Steel failure rebar									
Characteristic resistance for rebar BSt 500 S acc. to DIN 488 ¹⁾	$N_{Rk,s}$	[kN]	28	43	62	85	111	173	270
Partial safety factor for rebar BSt 500 S acc. to DIN 488 ²⁾	$\gamma_{Ms,N}$ ³⁾	[-]	1,4						
Combined Pull-out and Concrete cone failure									
Diameter of rebar	d	[mm]	8	10	12	14	16	20	25
Characteristic bond resistance in non-cracked concrete C20/25									
Temperature range I ⁴⁾ : 40°C/24°C	τ_{Rk}	[N/mm ²]	7,0	7,5	7,0	7,0	6,5	6,5	6,0
Temperature range II ⁴⁾ : 80°C/50°C	τ_{Rk}	[N/mm ²]	6.5	6.5	6,0	6,0	6,0	5,5	5,5
Increasing factor for $\tau_{Rk,p}$ in non-cracked concrete	ψ_c	C30/37	1,12						
		C40/50	1,23						
		C50/60	1,30						
Factor according to CEN/TS 1992-4-5 Section 6.2.2	k_8 non cracked concrete	[-]	10.1						
Concrete cone failure									
Factor according to CEN/TS 1992-4-5 Section 6.2.2	k_{ucr}	[-]	10.1						
Splitting failure									
Edge distance $c_{cr,sp}$ [mm] for	$h / h_{ef}^{5)} \geq 2,0$		1,0 h_{ef}						
	$2,0 > h / h_{ef}^{5)} > 1,3$		4,6 h_{ef} - 1,8 h						
	$h / h_{ef}^{5)} \leq 1,3$		2,26 h_{ef}						
Spacing	$s_{cr,sp}$	[mm]	2 $c_{cr,sp}$						
Partial safety factor	$\gamma_{Mp} = \gamma_{Mc} = \gamma_{Msp}$ ³⁾	[-]	1,8 ⁶⁾	1,8 ⁶⁾	1,8 ⁶⁾	1,8 ⁶⁾	1,8 ⁶⁾	1,8 ⁶⁾	1,8 ⁶⁾
<p>1) The characteristic tension resistance $N_{Rk,s}$ for rebars that do not fulfil the requirements acc. DIN 488 shall be calculated acc. Technical Report TR029, Equation (5.1).</p> <p>2) The partial safety factor $\gamma_{Ms,N}$ for rebars that do not fulfil the requirements acc. DIN 488 shall be calculated acc. Technical Report TR029, Equation (3.3a).</p> <p>3) In absence of national regulations</p> <p>4) Explanation see Annex B1</p> <p>5) h concrete member thickness, h_{ef} effective anchorage depth</p> <p>6) The partial safety factor $\gamma_2 = 1,2$ is included.</p>									
EJOT Multifix VSF						Annex C6			
Design according to CEN/TS 1992-4 Characteristic resistance under tension loads for rebars									

EJOT Multifix VSF with threaded rods			M 8	M 10	M 12	M 16	M 20	M 24
Steel failure without lever arm								
Characteristic resistance, class 5.8	$V_{Rk,s}$	[kN]	9	15	21	39	61	88
Characteristic resistance, class 8.8	$V_{Rk,s}$	[kN]	15	23	34	63	98	141
Characteristic resistance, class 10.9	$V_{Rk,s}$	[kN]	18	29	42	79	123	156
Characteristic resistance, A4-70	$V_{Rk,s}$	[kN]	13	20	30	55.0	86	124
Characteristic resistance, HCR	$V_{Rk,s}$	[kN]	15	23	34	62.8	98	124
Steel failure with lever arm								
Characteristic resistance, class 5.8	$M^0_{Rk,s}$	[Nm]	19	37	66	167	326	561
Characteristic resistance, class 8.8	$M^0_{Rk,s}$	[Nm]	30.0	60	105	266	519	898
Characteristic resistance, class 10.9	$M^0_{Rk,s}$	[Nm]	38	75	131	333	649	893
Characteristic resistance, A4-70	$M^0_{Rk,s}$	[Nm]	26	53	92	233	454	625
Characteristic resistance, HCR	$M^0_{Rk,s}$	[Nm]	30	60	105	266	519	786
Partial safety factor steel failure								
grade 5.8 or 8.8	$\gamma_{Ms,V}^{1)}$	[-]	1,25					
grade 10.9	$\gamma_{Ms,V}^{1)}$	[-]	1,50					
A4-70	$\gamma_{Ms,V}^{1)}$	[-]	1,56					
HCR	$\gamma_{Ms,V}^{1)}$	[-]	1,25					1,75
Concrete pryout failure								
Factor according to CEN/TS 1992-4-5 Section 4.3.3	k_3	[-]	2,0					
Partial safety factor	$\gamma_{Mcp}^{1)}$	[-]	1,5 ²⁾					
Concrete edge failure								
Partial safety factor	$\gamma_{Mc}^{1)}$	[-]	1,5 ²⁾					

¹⁾ In absence of national regulations

²⁾ The partial safety factor $\gamma_2= 1.0$ is included

EJOT Multifix VSF

Design according to CEN/TS 1992-4
Characteristic resistance under shear loads for threaded rods

Annex C7

EJOT Multifix VSF with rebar			Ø8	Ø10	Ø12	Ø14	Ø16	Ø20	Ø25
Steel failure without lever arm									
Characteristic shear resistance for rebar BSt 500 S acc. to DIN 488 ¹⁾	$V_{Rk,s}$	[kN]	14	22	31	42	55	86	135
Partial safety factor for rebar BSt 500 S acc. to DIN 488 ²⁾	$\gamma_{Ms,V}$ ³⁾	[-]	1,5						
Steel failure with lever arm									
Characteristic shear resistance for rebar BSt 500 S acc. to DIN 488 ¹⁾	$M^0_{Rk,s}$	[Nm]	33	65	112	178	265	518	1012
Partial safety factor for rebar BSt 500 S acc. to DIN 488 ²⁾	$\gamma_{Ms,V}$ ³⁾	[-]	1,5						
Concrete pryout failure									
Factor according to CEN/TS 1992-4-5 Section 4.3.3	k_3	[-]	2,0						
Partial safety factor	γ_{Mcp} ³⁾	[-]	1,5 ⁵⁾						
Concrete edge failure									
Partial safety factor	γ_{Mc} ³⁾	[-]	1,5 ⁵⁾						

- 1) The characteristic shear resistance $V_{Rk,s}$ for rebars that do not fulfil the requirements acc. DIN 488 shall be calculated acc. Technical Report TR029, Equation (5.6).
- 2) The partial safety factor $\gamma_{Ms,N}$ for rebars that do not fulfil the requirements acc. DIN 488 shall be calculated acc. Technical Report TR029, Equation 3.3b or 3.3c.
- 3) In absence of national regulations
- 4) The characteristic bending resistance $M^0_{Rk,s}$ for rebars that do not fulfil the requirements acc. DIN 488 shall be calculated acc. Technical Report TR029, Equation (5.6b).
- 5) The partial safety factor $\gamma_2 = 1,0$ is included.

EJOT Multifix VSF

Design according to CEN/TS 1992-4
 Characteristic resistance under shear loads for rebars

Annex C8

Displacement under tension load ¹⁾

EJOT Multifix VSF with threaded rods		M8	M10	M12	M16	M20	M24
Non cracked concrete temperature range I ⁷⁾: 40°C / 24°C							
Displacement	δ_{N0} [mm/(N/mm ²)]	0,03	0,03	0,04	0,05	0,06	0,07
Displacement	$\delta_{N\infty}$ [mm/(N/mm ²)]	0,07	0,09	0,10	0,13	0,17	0,20
Non cracked concrete temperature range II ⁷⁾: 80°C / 50°C							
Displacement	δ_{N0} [mm/(N/mm ²)]	0,04	0,04	0,05	0,07	0,08	0,10
Displacement	$\delta_{N\infty}$ [mm/(N/mm ²)]	0,10	0,13	0,15	0,19	0,23	0,28
Cracked concrete temperature range I ⁷⁾: 40°C / 24°C							
Displacement	δ_{N0} [mm/(N/mm ²)]	-	-	0,12	0,09	-	-
Displacement	$\delta_{N\infty}$ [mm/(N/mm ²)]	-	-	0,64	0,55	-	-
Cracked concrete temperature range II ⁷⁾: 80°C / 50°C							
Displacement	δ_{N0} [mm/(N/mm ²)]	-	-	0,17	0,13	-	-
Displacement	$\delta_{N\infty}$ [mm/(N/mm ²)]	-	-	0,90	0,78	-	-

EJOT Multifix VSF with rebar		Ø8	Ø10	Ø12	Ø14	Ø16	Ø20	Ø25
Temperature range I ⁹⁾: 40°C / 24°C								
Displacement	δ_{N0} [mm/(N/mm ²)]	0,03	0,03	0,04	0,04	0,05	0,06	0,07
Displacement	$\delta_{N\infty}$ [mm/(N/mm ²)]	0,07	0,09	0,10	0,12	0,13	0,17	0,20
Temperature range II ⁹⁾: 80°C / 50°C								
Displacement	δ_{N0} [mm/(N/mm ²)]	0,04	0,04	0,05	0,06	0,07	0,08	0,10
Displacement	$\delta_{N\infty}$ [mm/(N/mm ²)]	0,10	0,13	0,15	0,17	0,19	0,23	0,29

- ¹⁾ Calculation of displacement under service load: τ_{Sd} design value of bond stress
 Displacement under short term loading = $\delta_{N0} \cdot \tau_{Sd}/1,4$
 Displacement under long term loading = $\delta_{N\infty} \cdot \tau_{Sd}/1,4$

Displacement under shear load ²⁾

EJOT Multifix VSF with threaded rods		M8	M10	M12	M16	M20	M24
Displacement	δ_{V0} [mm/kN]	0,06	0,06	0,05	0,04	0,04	0,03
Displacement	$\delta_{V\infty}$ [mm/kN]	0,09	0,08	0,08	0,06	0,06	0,05

EJOT Multifix VSF with rebar		Ø8	Ø10	Ø12	Ø14	Ø16	Ø20	Ø25
Displacement	δ_{V0} [mm/kN]	0,06	0,05	0,05	0,04	0,04	0,04	0,03
Displacement	$\delta_{V\infty}$ [mm/kN]	0,09	0,08	0,07	0,06	0,06	0,05	0,05

- ²⁾ Calculation of displacement under service load: V_{Sd} design value of shear load.
 Displacement under short term loading = $\delta_{N0} \cdot V_{Sd}/1,4$
 Displacement under long term loading = $\delta_{V\infty} \cdot V_{Sd}/1,4$

EJOT Multifix VSF

Design
Anchor displacements

Annex C9